

# Gateway 4

These instructions will guide you through installing or replacing a Gateway 4

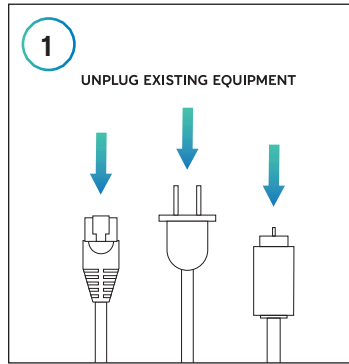

Disconnect everything from your existing equipment.

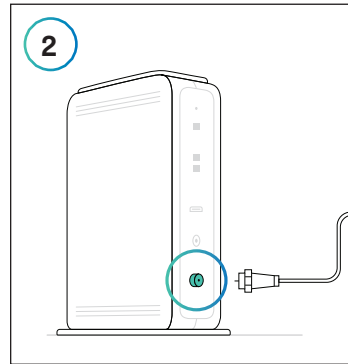

Connect the open end of your coaxial cable to the back of the new Gateway.

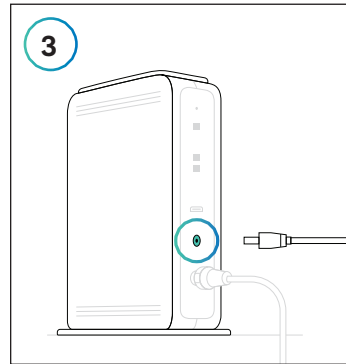

Plug the Gateway power cord into the back of the device.

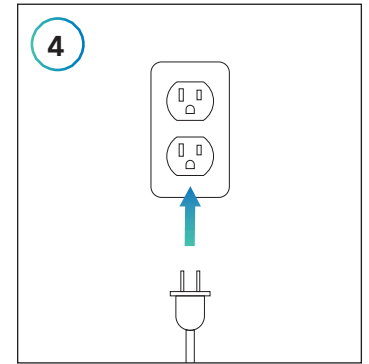

Plug the other end of the power cord into an electrical outlet.

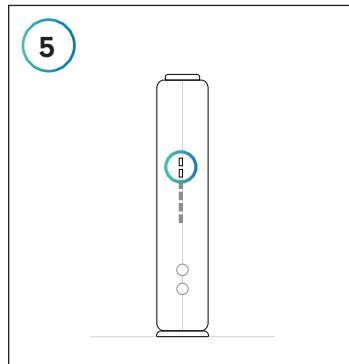

The Gateway is ready for the next step when the top 2 lights (DS/US, INTERNET) on the front panel are solid white. **This may take a few minutes.**

Once you've connected and powered on your new Gateway, call **888.570.4702** to begin the activation process.

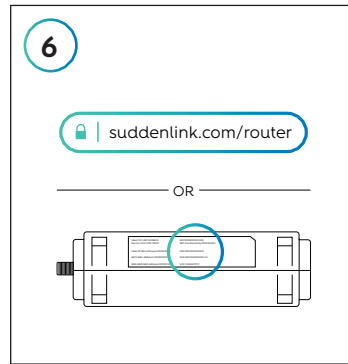

Sign in at **suddenlink.com/router** to personalize your in-home WiFi network name, also called a SSID, and your password. Can't remember or don't have a Suddenlink username? Visit **suddenlink.net/myaccount**

If you'd rather use the defaults, look at the label on the bottom of the Gateway. Note, your password will be listed as the "WiFi Password".

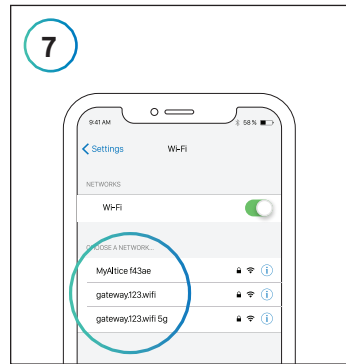

To connect to the Internet, go to WiFi settings on your device. Select your in-home WiFi network name from the list and when prompted, enter your password.

Repeat this step for all of your connected devices.

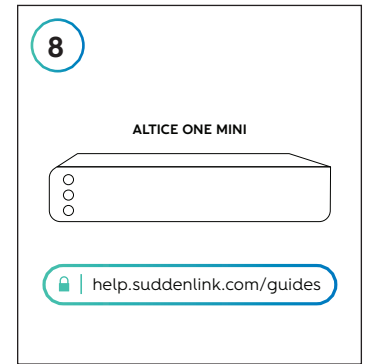

If you have an **Altice One Mini**, you need to re-pair it to the Gateway. Refer to the "Replacing an Altice One Mini" instructions at **help.suddenlink.com/guides**. If not, you're all set!

